



WaveGuide Height & Tide

User Manual

WaveGuide Height & Tide User Manual

Applicable for product number:
WG-HT40-SS

Related to software version:
wht 4.0-0

Version 4.0
3rd of Jun. 2016



Radac B.V.
Elektronicaweg 16b
2628 XG Delft
The Netherlands
tel: +31(0)15 890 3203
e-mail: info@radac.nl
website: www.radac.nl



Preface

This user manual and technical documentation is intended for engineers and technicians involved in the software and hardware setup of the stainless steel (non ATEX certified) version of the WaveGuide Height & Tide.

Note

All connections to the instrument must be made with shielded cables with exception of the power supply. The shielding must be grounded in the cable gland or in the terminal compartment on both ends of the cable. Please refer to Chapter 2 for more details regarding wiring and cable specifications.

Legal aspects

The mechanical and electrical installation shall only be carried out by trained personnel with knowledge of the local requirements and regulations for installation of electronic equipment.

The information in this user manual is the copyright property of Radac BV.

Radac BV disclaims any responsibility for personal injury or damage to equipment caused by:

- Deviation from any of the prescribed procedures.
- Execution of activities that are not prescribed.
- Neglect of the general safety precautions for handling tools and use of electricity.

The contents, descriptions and specifications in this user manual are subject to change without notice. Radac BV accepts no responsibility for any errors that may appear in this user manual.

Additional information

Please do not hesitate to contact Radac or its representative if you require additional information.

Contents

Preface

Introduction	1
1 Radar positioning and installation	3
1.1 Safety notes	3
1.2 Positioning	4
1.3 Installation	5
2 Wiring	6
2.1 WaveGuide radar	6
2.2 Separate power supply for the radar	7
2.3 WaveGuide processing unit	7
3 WaveGuide system commissioning	9
Step 1. Connect the WaveGuide processing unit to a computer	10
Step 2. Become an authorized user	11
Step 3. Configuration	11
Step 3.1: Set system date and time	11
Step 3.2: Adjust network settings	12
Step 3.3: Sensor configuration	13
Step 4: Perform system check	14
Step 4.1: Check System Information page	14
Step 4.2: Check reflection diagrams	16
Step 4.3: Check measurements	16
Step 5: Configure distribution of data	16
4 Using the system	19
4.1 Calculated parameters	19
4.2 Data logging	19
Appendix 1: System parameters	21
Appendix 2: System specifications	24

Introduction

The WaveGuide Height & Tide is a highly accurate wave, tide and waterlevel monitoring system which is compact, robust and easy to install.

The WaveGuide Height & Tide consists of:

- A WaveGuide radar, to be mounted above water level.
- A WaveGuide processing unit, to be installed in a control room or in a terminal box.

The WaveGuide radar is a low power X-band FMCW radar that measures the distance between the water surface and the radar antenna with an accuracy of < 1 [cm]. The raw reflection signal is communicated to the WaveGuide processing unit which performs all calculations, from the distance to the water to all the available wave parameters.

The WaveGuide processing unit collects the measurements, and provides the wave and tide information on both a physical user interface and a web-based interface. The WaveGuide processing unit also facilitates data storage and data broadcasting.

Warning

Do not use the instrument for anything else than its intended purpose.

This manual consists of 4 chapters. Chapter 1 specifies the WaveGuide radar positioning criteria for optimal measurement quality. Chapter 2 illustrates the mounting and installation procedure. Chapter 3 describes the commissioning of the system via the user interface. Chapter 4 explains data processing the and option for data logging.

Please refer to Appendix 1 for a list of measured and calculated parameters. And to Appendix 2 for specifications, information about certification and environmental conditions applicable to the WaveGuide Height & Tide.

Chapter 1

Radar positioning and installation

1.1 Safety notes

The personnel installing the WaveGuide must have basic technical skills to be able to safely install the equipment. When the WaveGuide is installed in a hazardous area, the personnel must work in accordance with the local requirements for installation of electrical equipment.

Caution

Modification to the instrument may only be carried out by trained personnel that are authorized by Radac BV. Failure to adhere to this will invalidate the approval certificate.

Warning

In hazardous areas it is compulsory to use personal protection and safety gear such as: hard hat, fire-resistive overall, safety shoes, safety glasses and working gloves.

Avoid possible generation of static electricity.

Use non-sparking tools and explosion-proof testers.

Make sure no dangerous quantities of combustible gas mixtures are present in the working area.

Never start working before the work permit has been signed by all parties.

Warning

Make sure that all power to the instrument is switched off before opening the covers of the WaveGuide radar. Failure to do so may cause danger to persons or damage the equipment.

All covers of the WaveGuide radar must be closed before switching on the power.

1.2 Positioning

For obtaining the best results from a WaveGuide Height & Tide the following radar positioning criteria must be taken into account:

- It is advised to choose a mounting position such that the WaveGuide radar beam is free of large reflecting obstacles (the beam of the F08 antenna can be approximated to a conical shape having a 5° [deg] half top angle as shown in Fig. 1.1). The minimum horizontal distance between the radar and any obstacle in the beam's path should be at least 10% of the vertical distance between the radar and the obstacle. This does not only include horizontal objects in the beam's path but also vertical structures.
- Any structure that the WaveGuide radar is mounted to might have some influence on the waves progressing around it. Hence, it is advised to mount the radar at a position facing the expected mean wave direction, such that the radar can measure the least disturbed water surface
- The reference point for the mounting height of the radar is shown in Fig.1.2.
- A vertically mounted radar (0° [deg] tilt angle) results in optimal performance. But if necessary the WaveGuide radar can be mounted with a maximum tilt angle of 15° [deg] (tilted to face the direction away from the structure it is mounted to).

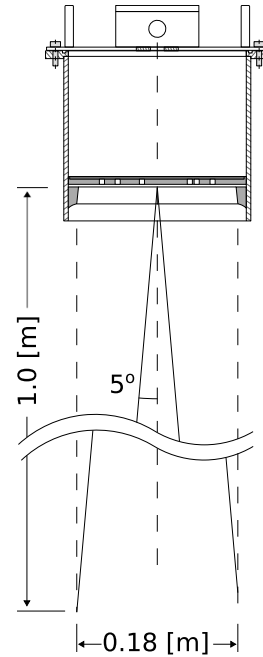

Figure 1.1: The 5° [deg] half top angle of the F08 antenna beam.

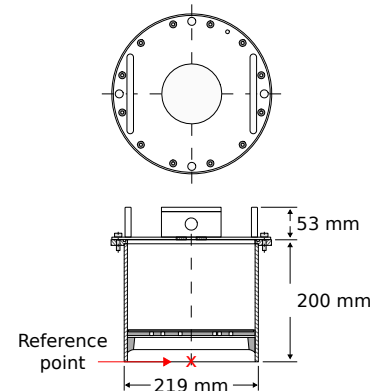

Figure 1.2: The reference point for mounting height measurement and radar position.

1.3 Installation

To facilitate the mounting of the WaveGuide radar, an optional mounting plate is available upon request (Part no. WG-MP-SS). Figure 1.3 shows a sketch of the optional mounting plate and its dimensions.

The mounting plate can be fixed to two horizontal beams (Fig. 1.4). The length of the beams must take into account the minimum horizontal distance between the WaveGuide radar and any obstacles in the path of the radar signal (as explained in the radar positioning criteria).

The outside diameter of the WaveGuide radar cylinder is 219 [mm] and the total height of the system is 253 [mm]. The radar cylinder has a flange (265 [mm] diameter) that contains 4 mounting holes each having a diameter of 11 [mm].

It is advised to mount the horizontal beams first. Then to attach the mounting plate to the horizontal beams and finally to mount the WaveGuide radar to the mounting plate.

The optional mounting plate has 4 threaded mounting holes (M10 thread) for mounting the WaveGuide radar to the mounting plate.

Upon request, Radac can supply an optional frame (Part no. WG-MH-SS) that allows for mounting the WaveGuide radar and mounting plate at angles 0, 5, 10, 15 and 20 [deg] away from vertical (see Fig.1.5). The radar mounting plate (Part no. WG-MP-SS) is included with this frame as well as brackets to allow mounting the frame to a handrail.

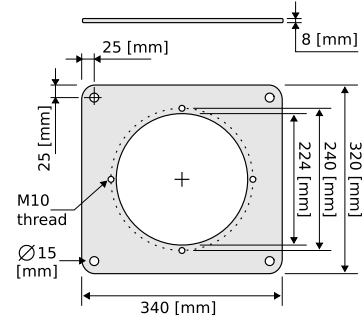

Figure 1.3: Optional mounting plate for the WaveGuide radar.

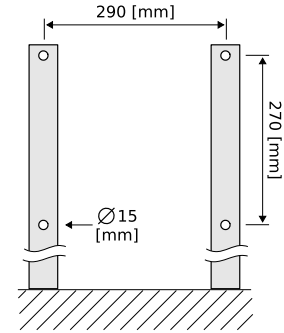

Figure 1.4: Top view of the horizontal mounting beams.

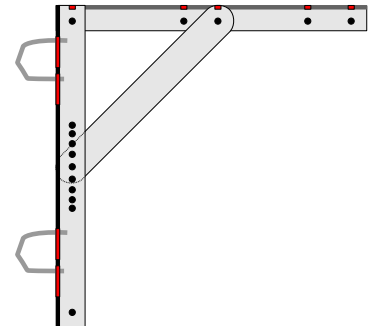

Figure 1.5: Optional frame that allows mounting of the WaveGuide radar at different angles.

Chapter 2

Wiring

2.1 WaveGuide radar

A cable gland (IP68-10bar and IP69K certified) is supplied with each WaveGuide radar for use on the terminal compartment as a watertight cable entry point. The supplied gland allows the installation of insulated cables from 8 to 15 [mm] in diameter.

In the terminal compartment there is one five pole connector as shown in Fig. 2.1. The connector is used to connect the RS485 data wires (poles labeled with both A, B, GND and 1, 2, 3) and supply power to the radar (poles labeled + and -).

The length of the cable used to connect the radar to the processing unit can not exceed 1200 [m].

The cable used must be shielded and the shielding must be connected to ground at both ends of the cable. Since there can be a potential difference between the ground at the radar and the ground at the processing unit, a capacitor (10 to 100 [nF]) should be used on one side of the cable between its shield and the ground.

The cable used must contain at least one twisted pair of wires for use with the RS485 data signal (poles labeled A and B). In addition, the cable must contain one wire for the signal ground (pole labeled Gnd) and two wires for supplying power from the WaveGuide processing unit to the WaveGuide radar (poles labeled + and -).

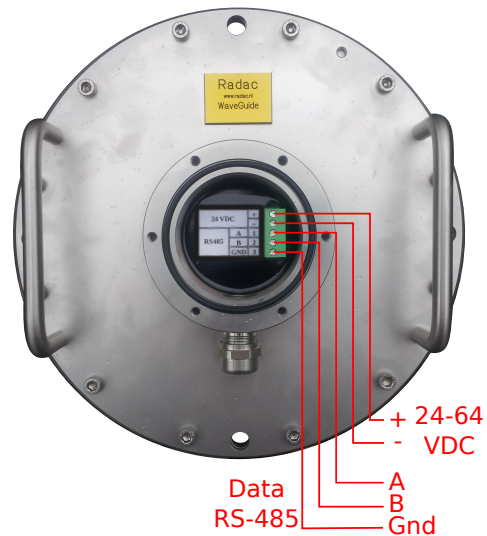

Figure 2.1: Terminal compartment and connections.

Warning

Improper wiring can damage the radar's communication board. Always check that the + and - 24-64VDC is applied to the right terminals before plugging in the connector!

Warning

Safety depends on proper grounding of the radar housing. Check the resistance of the ground connection directly after installation. The measured ground resistance shall be below the maximum prescribed by local grounding requirements.

2.2 Separate power supply for the radar

In some cases it is more convenient to use a separate power supply to power the WaveGuide radar rather than supplying it with power from the processing unit side. In that case a 24-64 [VDC] power supply can be used on the WaveGuide radar side to supply it with 6 [Watt] of power.

If a separate power supply is used for the WaveGuide radar, then the cable used to connect the processing unit to the radar does not need the extra two wires for power. In that case, three wires in the cable between the processing unit and radar will be sufficient (one twisted pair and a signal ground wire).

In the case that a separate power supply is used to power the radar, then the processing unit can be supplied with a power supply of 12-48 [VDC].

2.3 WaveGuide processing unit

For ease of use, the connector poles common between the WaveGuide processing unit and radar are marked using the same labeling symbols.

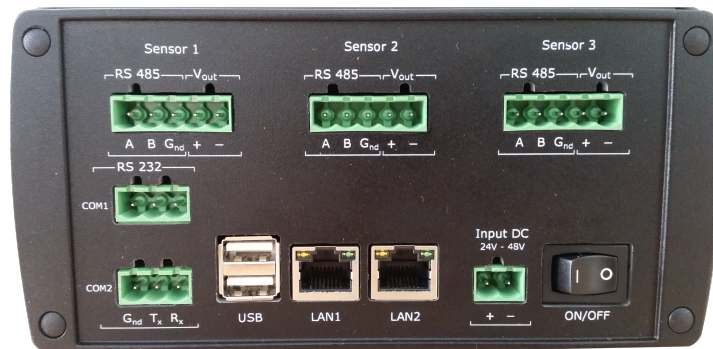

Figure 2.2: Connector panel on the WaveGuide processing unit.

The connector panel of the WaveGuide processing unit includes the following connectors, along with their function specific to the WaveGuide Height & Tide:

- Sensor 1: The provided WaveGuide radar must be connected to the 'Sensor 1' port.
- Sensor 2: Not used for the WaveGuide H&T.
- Sensor 3: Not used for the WaveGuide H&T.
- COM1: Serial port for RS-232 data output.
- COM2: Serial port for RS-232 data output.
- USB: For connecting a USB data storage.
- LAN ports: Ethernet access to the processing unit.
- Input DC: For supplying the system with 24V to 48V power.

Warning

The WaveGuide Height & Tide requires the radar to be connected to the port labelled as 'Sensor 1'.

When the radar is powered through the processing unit, then the power supply for the processing unit must be 24-48 [VDC] and capable of providing at least 12 Watt. Please do take into account the voltage drop due to wire resistance between the processing unit and the radar, the radar must at all times receive more than 21.0 V. For this reason, to be sure to stay within the limits, at longer distances it is advised to use a 36V or 48V power supply. The power feed-through to the WaveGuide radar is controlled by the power switch on the WaveGuide processing unit.

Chapter 3

WaveGuide system commissioning

With all the wiring in place as described in the previous chapter, the processing unit can be configured using the following steps (explained in the current chapter):

1. Connect the WaveGuide processing unit to a computer.
2. Become an authorized user.
3. Configure the system.
4. Perform a system check.
5. Configure the distribution of data.

The display on the processing unit shows system information and measured parameters and is controlled using the buttons on the front:

- Left and right: To switch between groups.
- Up and down: To switch between items within each group.
- OK: To confirm mounting and unmounting of USB data storage.

The processing unit display contains the following groups and items:

- Parameters
 - Scrolls through selected parameters
- Network
 - Host name
 - IP address
- System information
 - Date and time
 - Uptime
 - Software version
- USB storage (only appears when USB device is connected)
 - State
 - Mount USB disk?/ Unmount USB disk?

Step 1. Connect the WaveGuide processing unit to a computer

Once the WaveGuide processing unit is connected to a Local-Area-Network, communication with the WaveGuide processing unit can be done via the available web interface (Fig. 3.1). For this purpose any web browser with JavaScript enabled can be used.

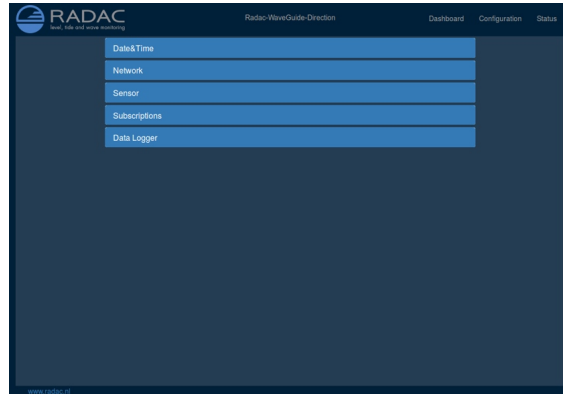

Figure 3.1: The web interface of the WaveGuide processing unit.

Note

A computer can be connected to the WaveGuide processing unit directly using a network cable (a crossover cable is not required).

By default, during startup the WaveGuide processing unit tries to obtain an IP address by searching the Local-Area-Network for a DHCP server. If a DHCP server is not found, the WaveGuide processing unit will use the default IP address 192.168.111.71.

When the WaveGuide processing unit completes the startup process, its IP address can be found via the LCD display (it can take up to 5 minutes for the IP-address to appear). To view the IP address, scroll through the menu using the left and right buttons until network information is displayed and then use the up and down buttons to switch between displaying the Host-Name and the IP address.

An other way of locating the system in a network is by making use of the installed Zeroconf client. Using a Zeroconf browser makes it easy to find the WaveGuide system.

To access the web interface, type the IP address indicated on the LCD display in the address line of your web browser (e.g. 192.168.111.71). Note, that your computer must be on the same IP address subnet as the WaveGuide processing unit that you are trying to connect to.

The WaveGuide processing unit homepage contains three main sections (Dashboard, Configuration and Status) as listed in Table 3.1.

Link	Description
Dashboard	Visualisation of the measured data.
Configuration	Changing the settings and configuration of the system.
Status	System state overview and general information.

Table 3.1: Description of processing unit main sections.

Step 2. Become an authorized user

To modify the WaveGuide system's configuration you need to be an authorized user. Therefore, an authorization dialogue will appear when the user enters the configuration page.

The authorization will be valid for a duration of 30 minutes. However, the web browser may store the login name and password. In that case, the authorization data will be submitted automatically by the browser without a pop-up dialog. The default login password is "radac".

After successful authorization, the user can view and change settings. After submitting any new settings a reboot dialog will appear. The settings will not be effective until the WaveGuide processing unit is rebooted.

Step 3. Configuration

The configuration page contains five sections as listed in Table 3.2.

Link	Description
Date&Time	For viewing and setting the system time.
Network	For viewing and changing the network settings.
Sensor	For viewing and changing the sensor specific settings and for viewing reflection diagrams.
Subscriptions	To set up data export over the serial ports or over the network.
Data Logger	To log data on a USB drive.

Table 3.2: Description of configuration page sections.

Step 3.1: Set system date and time

In order to ensure an accurate timestamping of the data, the WaveGuide processing unit runs an ntp time service to automatically correct its system time to UTC time. For the ntp service to work, the system needs to be connected to the Internet, as it needs to be able to reach its default ntp servers.

In the case that the ntp servers can not be reached, it is possible to manually set the system date and time using the "Date&Time" menu (Fig. 3.2). Adjusting the date and time while the ntp service is running is not possible as the time will be automatically corrected back to UTC time. The date and time are kept by an on-board clock. Please be aware that such on-board clocks are not highly accurate and can drift over the years while the system is used.

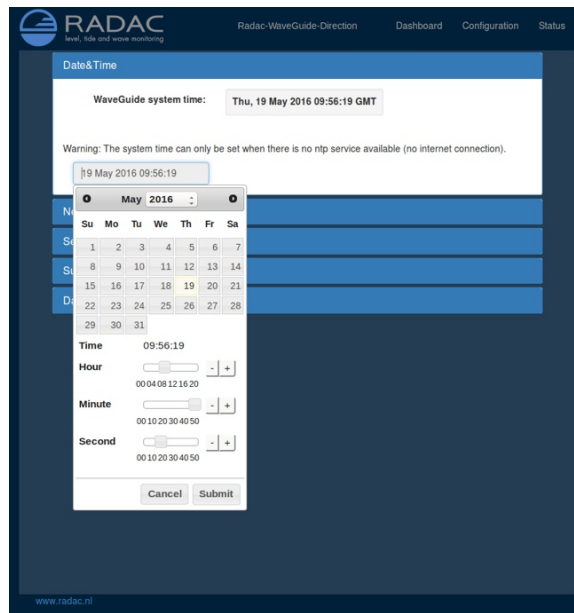

Figure 3.2: Setting the system time and date.

If the WaveGuide is not connected to the internet but instead connected to a local network that includes a time server, then the processing unit can be adjusted to synchronize time and date with the local time server. For more information regarding such an adjustment please contact Radac.

Step 3.2: Adjust network settings

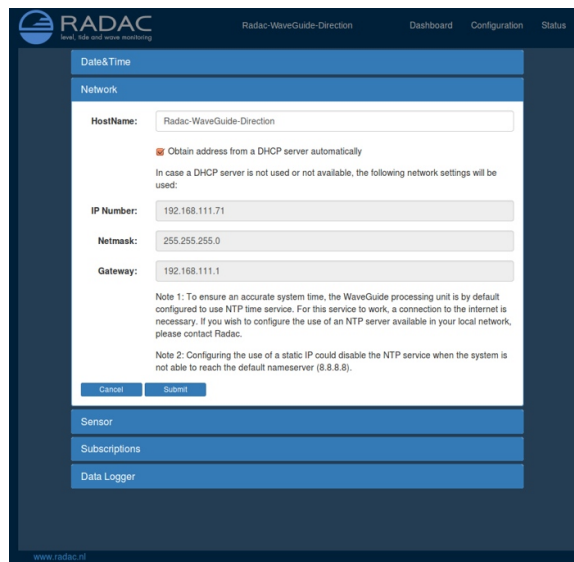

Figure 3.3: Adjusting the network settings.

The default IP address can be modified via the web interface (Fig. 3.3). It is advised to use the default setting, to automatically obtain the network settings from a DHCP server, and assure from the side of the DHCP server that the system will receive the same IP address

at all times. This setting provides the easiest setup and ensures the correct settings for the local network.

To ensure an accurate system time, the WaveGuide processing unit is by default configured to use an ntp time service. For this service to work, a connection to the Internet is necessary.

Configuring the use of a static IP could disable the NTP service when the system is not able to reach the default nameserver (8.8.8.8).

Step 3.3: Sensor configuration

The WaveGuide Height&Tide is designed with a high level of flexibility in mind, to apply to every possible mounting situation. The sensor menu allows the configuration of those parameters that are specific to the sensor installation. The mounting height above the reference water level, and possibly a number of other parameters, needs to be set for each specific mounting location. This can be done in the configuration table that is shown in Fig. 3.4.

Radar sensor	
Mounting height [m]	<input type="text" value="10.0"/>
Tilt angle [deg]	<input type="text" value="0.0"/>
Max. range [m]	<input type="text" value="75.0"/>
Min. range [m]	<input type="text" value="3.14"/>
Min. signal [dB]	<input type="text" value="20.0"/>
Sensor Type	<input type="text" value="Stainless steel"/>
Meas. freq. [Hz]	<input type="text" value="2.56"/>
Reflection diagram	<input type="button" value="Plot"/>

Figure 3.4: Setting sensor parameters (changes only take effect after the system is rebooted).

Mounting height

The mounting height is defined as the height of a radar above the reference water level in [cm]. The reference point for measuring the height of each radar is the lower-side of the radar housing (as shown in Fig. 1.2). By default, the mounting height is set to zero [cm].

Tilt angle

The tilt angle, or the angular deviation from the vertical at which the radar is mounted, is measured in degrees. It can be used to tilt the radar reflection footprint away from the mounting construction. It is advised to only apply a tilt angle when it is really necessary.

Max. range

The range maximum is the maximum distance at which the sensor will detect the water level. In general there is no need to modify this parameter. Yet in some situations it is advised to set this parameter to a value lower than two times the distance from the radar to the lowest expected water level. This is to avoid detecting multiple echoes of the same measurement sweep.

Min. range

The range minimum is the minimum distance at which the sensor will detect the water level. This parameter is used to avoid spurious measurements and should be set depending on the installation location. If there are any nearby surfaces that can reflect the radar signal the range minimum should be set to a value higher than the distance to those reflecting surfaces. The range minimum parameter should not be lower than 2 [m] to avoid interference with the internal reflection in the radar antenna.

Min. signal

The signal minimum is the lower limit for the signal power that will be considered in water level measurements. This parameter should be set to 20 [dB] in the case of a vertically mounted radar and set to 5 [dB] in the case of a tilted radar.

Sensor type

Radac brings two types of radars to the market, the Stainless Steel radar and the ATEX certified EX radar. Both radars require a different offset value that accounts for the internal path-length of the radar signal due to the difference in geometry. Selecting the right sensor type means that the right reference is used for measuring the distance between the radar and the water surface.

Reflection diagram

The reflection diagram gives a snapshot of raw radar data in the frequency domain. The reflection diagram provides a useful insight in the quality of the reflection signal that is obtained by the radar.

After changing the sensor parameters for the radar, rebooting the system is required for the changes to take effect. The reflection diagram of the sensor should be checked to ensure that the water level measurement is within the defined limits (More information can be found in 'Step 4.2: Check the Reflection Diagrams').

Step 4. Perform system check

This section explains how to inspect the quality of measurements after configuring and rebooting the WaveGuide processing unit (the start-up process can take up to 5 minutes):

Step 4.1: Check system information page

The system information table can be reached through the status menu item on the top-right of the web interface. The system info page displays the communication status (as shown in Fig. 3.5). A communication status "INIT" indicates that the WaveGuide processing unit is initiating the communication process with the radar. Once the communication process is initiated (a process that can take up to five minutes after reboot) the displayed status becomes 'OK'.

System Information	
WaveGuide System	
Hardware serial number:	1614_1010
Base software version:	4.0-0
WGS software version:	wdi 0.0-12
Last reboot:	Thu, 19 May 2016 07:41:06 GMT
Current system time:	Thu, 19 May 2016 08:13:20 GMT
Communication status:	OK
Number of measurements:	18794
Invalid measurements:	2
Timeouts:	0
Server Temperature:	38.02°C
Server Humidity:	16.47%

Figure 3.5: System information.

In the same table, the ratio between the number of performed and invalid measurements gives an indication of the system performance. When the system is set up in a correct manner, the number of invalid measurements should be below 10% of the number of performed measurements. However, during the start up and communication initiation processes the number of invalid measurements can grow to over 1000 (temporarily increasing the ratio between invalid measurements and performed measurements). The number of invalid measurements will show a slow increase after the initial invalid measurements.

Step 4.2: Check reflection diagrams

The reflection diagram of the radar can be accessed via the sensor configuration page by clicking on the corresponding "reflection" button (Fig. 3.6).

A reflection diagram is a graphic representation of a 25 [ms] scan, where the signal strength [dB] is plotted against the measurement distance [m]. A scan consists of one up-sweep (increasing frequency, blue curve) and one down-sweep (decreasing frequency, red curve).

In some cases several peaks are visible in a reflection diagram as shown in Fig. 3.6. This is called a double reflection and is caused by the radar signal bouncing back and reflecting from the water surface for a second time. The signal processing takes this phenomenon into account such that it does not have a negative effect on the measurements.

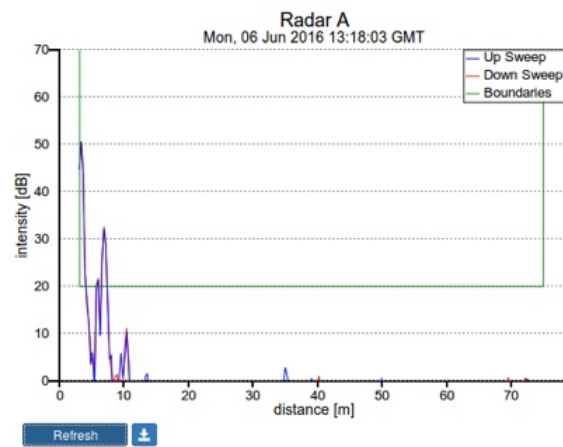

Figure 3.6: The reflection diagram gives a graphical representation of the radar signal received in a single measurement.

Based on the defined range maximum and minimum values, the WaveGuide system shows the applied boundaries using vertical green lines. A horizontal green line shows the minimum accepted reflection strength (the value set as the Signal Minimum [dB] parameter). The three green lines together form a region in which a measurement is accepted, and any result outside of it is ignored.

Step 4.3: Check measurements





On the 'Dashboard' page, the heave parameter shows data measured during the last 1, 3 or 10 minutes. Please inspect the available heave and slope graphs to visually confirm the measured data. From the same menu all calculated parameters are available. Please take into account that it can take up to 10 minutes to gather enough raw data to calculate the parameters.

Step 5. Configure distribution of data

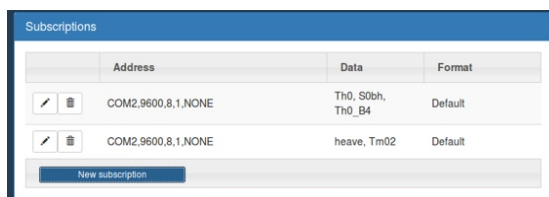
The WaveGuide processing unit can transmit measured and calculated data via its serial ports (COM1 & COM2) and distribute data over the network by sending UDP messages to

several addresses at the same time. In the 'Subscriptions' page under 'Configuration'(Fig. 3.7 and Fig. 3.8), the existing subscriptions can be removed or modified and new ones can be added. Simultaneous subscriptions are possible.



	Address	Data	Format
 	COM2,9600,8,1,NONE	Th0, S0bh, Th0_B4	Default
 	COM2,9600,8,1,NONE	heave, Tm02	Default

New subscription

Figure 3.7: List of defined subscriptions.

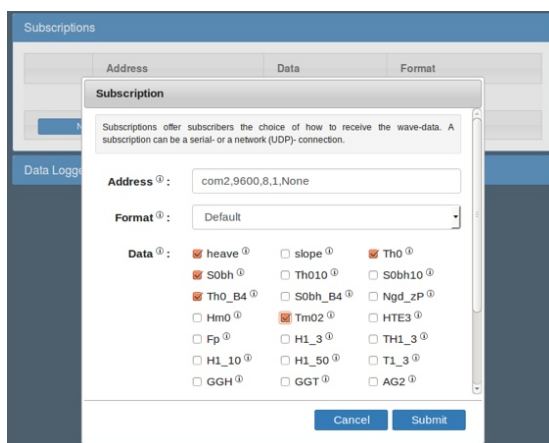

Subscriptions offer subscribers the choice of how to receive the wave-data. A subscription can be a serial- or a network (UDP)- connection.

Address [Ⓢ]: com2,9600,8,1,None

Format [Ⓢ]: Default

Data [Ⓢ]:

- heave [Ⓢ] slope [Ⓢ] Th0 [Ⓢ]
- S0bh [Ⓢ] Th010 [Ⓢ] S0bh10 [Ⓢ]
- Th0_B4 [Ⓢ] S0bh_B4 [Ⓢ] Ngd_zP [Ⓢ]
- Hm0 [Ⓢ] Tm02 [Ⓢ] HTE3 [Ⓢ]
- Fp [Ⓢ] H1_3 [Ⓢ] TH1_3 [Ⓢ]
- H1_10 [Ⓢ] H1_50 [Ⓢ] T1_3 [Ⓢ]
- GGH [Ⓢ] GGT [Ⓢ] AG2 [Ⓢ]

Cancel Submit

Figure 3.8: Subscriptions dialog.

The address for a serial port subscription should have the following format: 'port', 'baud-rate', 'number of data bits', 'number of stop bits', 'parity', 'handshake'. For example the default values are, COM2,9600,8,1,NONE,NONE.

If the address string is not complete the default values will be used. For example, COM2,9600 will be interpreted as COM2,9600,8,1,NONE,NONE.

The format for the network message is: 'ip.address:port'. For example, 192.168.111.103:8032.

The format of the output string can be chosen from the drop-down menu. Four message format options are available, Default, Format01, Format02 and Format03.

After modifying or creating a new subscription, click the 'update' button and authorize the changes. This will change and store the settings and implement the subscription with immediate effect (no system reboot is required).

Default message format

The Default format starts a new line for each parameter in the subscription. The time used in the Radac format is Unix Epoch time in milliseconds (UTC time in milliseconds since 00:00:00 on the 1st of January 1970). Each line in the Default format ends with a Line-Feed character (char10). When a parameter is disapproved or not available the string 'NaN' is

inserted instead of the actual value (NaN stands for Not a Number). An example of the output strings in the Radac format is:

```
time=1157359800206;sensor=radcan;H1=-319.9429cm;  
time=1157359259847;sensor=radcan;Hm0=1.2517135cm;  
time=1157359860268;sensor=radcan;H1=NaNcm;
```

Format01 message format

Modifications can be made upon request. For example, the Korean Meteorological Administration (KMA format) preferred a readable time format in the Korean time zone. An example of the output strings in the KMA format is:

```
time=2006/09/04 17:58:00;H1=-319.70026cm;  
time=2006/09/04 17:48:59;Hm0=1.3314528cm;  
time=2006/09/04 17:59:00;H1=NaNcm;
```

Format02 message format

The Format02 message, formerly called the SESAM format, used by the Dutch Ministry of Infrastructure and the Environment (Rijkswaterstaat), is only defined for the heave and the 10 second mean (H parameter). It consists of 8 character lines (Line-Feed character + status character + sign character + 4 character value in cm + Carriage-Return character). For a regular message the status character is a space. If an error occurs the status character becomes a letter A. An example of the output strings in the RWS format is,

```
+0001  
- 0004  
A+9999
```

Format03 message format

The Format03 message, formerly called the FGTI format, is used by the Belgium government. Where one string is used for all required information (parameters + spectrum) per processing interval. The chosen parameters are separated by a semicolon (;) and the 51 spectrum values (czz10) are included. The 'NaN' string is replaced with a '-9999' string. An example of the output string in the FGTI format is:

```
time=1159898219628;sensor=radcan;H1/3=0.101608045cm;Hm0=0.070818946cm;Czz10=0.0,5.0869432E-5,  
1.3970293E-4,4.7124052E-4,7.1615004E-4,7.975558E-4,7.6214876E-4,7.1647903E-4,7.6107396E-4,6.847791E-  
4,6.6441507E-4,4.567583E-4,7.3393347E-4,8.3342794E-4,7.177321E-4,8.320104E-4,9.631133E-4,4.7024636E-  
4,5.479116E-4,7.0798665E-4,7.973897E-4,8.964213E-4,0.0010354978,5.15721E-4,8.0113555E-4,8.009798E-4,  
8.0272334E-4,8.0752687E-4,6.5126666E-4,8.172201E-4,5.1516114E-4,6.2683446E-4,5.63858E-4,3.5074513E-4,  
6.5980386E-4,5.53472E-4,7.269641E-4,6.289437E-4,6.156702E-4,5.8503065E-4,6.2185246E-4,5.5198127E-4,  
4.41777E-4,2.7770927E-4,3.3221033E-4,7.5746316E-4,6.8937184E-4,6.167301E-4,7.730603E-4,6.513776E-4,  
5.5705215E-4cm2/Hz;
```

Chapter 4

Using the system

4.1 Calculated parameters

Once the system is commissioned the facilities of data presentation, reflection diagram, system info etc. can be used to monitor the proper operation of the system.

Water level and wave height information are calculated by analyzing the measurements of the WaveGuide radar. There are two analysis routines:

Wave analysis

The Standard Wave Processing Package (SWAP) is used in performing time and frequency domain analysis on the measured data to calculate wave parameters. This package is the standard processing package used by the Dutch government for wave height analysis. It also meets the standards set by The International Association of Oil & Gas Producers (OGP). A detailed description of the SWAP package is available on the Radac website (<http://www.radac.nl>).

The SWAP parameters are calculated every minute using 20 minute data blocks. The 20 minute observation block is chosen as a compromise between short enough to obtain "small" variance in the statistical parameters and long enough to assume it to be a stationary process. The time stamp used on SWAP parameters is the mean between the start and end time of the 20 minute data block.

Tide analysis

The tide parameters H10, H5 and H1 are calculated by averaging measured data over 10 [min], 5 [min] and 1 [min] periods respectively.

Each parameter receives a time stamp central to the block of data that was used for its calculation. The spectra and parameters that can be calculated by the WaveGuide system are described in Appendix 1. Due to the large number of parameters, only a selection of the most commonly used ones is displayed on the user interface. This selection can be modified by Radac upon request.

4.2 Data logging

A USB storage device can be easily mounted to the WaveGuide processing unit for data logging. It needs to be said that without taking additional precautions, USB storage is not a safe method for archiving data. Since power failures can damage USB devices, it is advised to use an Uninterrupted Power Supply (UPS) together with a high quality USB device. Having said this, usb storage provides a great backup option while sending data out over a serial or network connection.

The WaveGuide processing unit supports FAT32 , Ext2 and Ext3 formats. The majority of USB devices is delivered with FAT32 format.

Note

The USB device used must not be formatted using NTFS.

A USB drive must be manually mounted when first used, and will be automatically re-mounted on system reboot. Mounting a USB drive can be done via the push buttons on the front panel of the WaveGuide processing unit. Use the right arrow button to scroll to the storage menu. If the message 'Disk not mounted' is displayed, click the down button. If the message 'Mount USB disk? OK' is displayed, click OK to mount the device.

To unmount or remove the disk safely, use the right arrow button to scroll to the storage menu. Then click the down button to arrive at the "Safely remove? OK" option. Clicking the OK button safely unmounts the device.

The 'Data Logger' page in the web user interface (Fig. 4.1) gives access to the stored data. Also the data can be transferred easily to other computers using an FTP application. Login name and password for FTP file transfers are the same as the user-name and password for modifying settings (by default both user-name and password are 'radac')

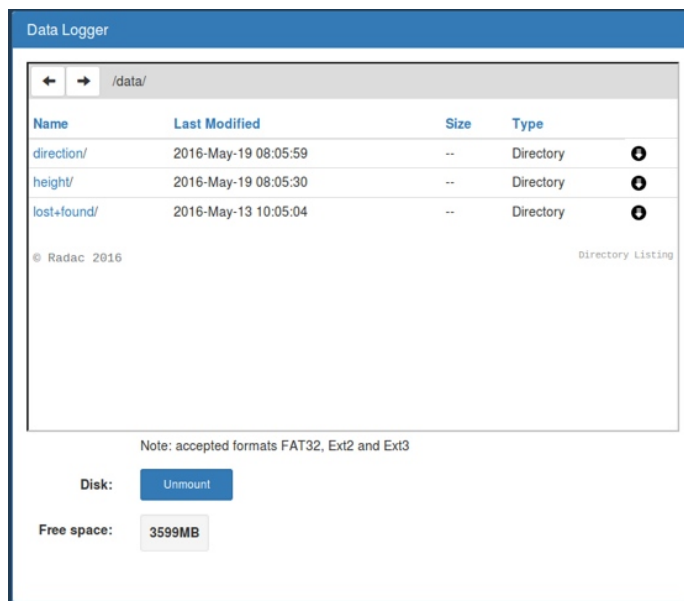

Figure 4.1: Data logger page.

The folder structure used is one directory per system. In this directory, sub-directories are created that contain the raw data and parameter files (one file per day per parameter).

If the drive is full, a delete mechanism starts. This allows the system to store the most recent parameters at the expense of the oldest data.

Appendix 1: System parameters

Default parameters

A selection of the raw and processed parameters is by default available for plotting, storing and export (Table 1).

Name	Description	Unit
heave	Instantaneous water level	<i>cm</i>
Ngd_zP	Percentage of data points that do not contain error code before pre-processing	%
Hm0	Significant wave height from M0	<i>cm</i>
Tm02	Average period from M0 and M2 in the range $f=[30-500]$ mHz	<i>s</i>
HTE3	Wave height from TE3 (band energy from Czz10(f) where $f=[30-100]$ mHz)	<i>cm</i>
Fp	Frequency f where Czz10(f) has its maximum in the range $f=[30-500]$ mHz	<i>mHz</i>
H1/3	Average height of the highest 1/3 of the waves	<i>cm</i>
TH1/3	Average period of the highest 1/3 of the waves	<i>s</i>
H1/10	Average height of the highest 1/10 of the waves	<i>cm</i>
H1/50	Average height of the highest 1/50 of the waves	<i>cm</i>
T1/3	Average period of the longest 1/3 of the periods	<i>s</i>
GGH	Average height of all waves	<i>cm</i>
GGT	Average period of all waves	<i>s</i>
AG2	Number of waves	—
SPGH	Standard deviation of the wave height	<i>cm</i>
SPGT	Standard deviation of the wave period	<i>s</i>
Hmax	Height of highest wave	<i>cm</i>
Tmax	Period of longest wave	<i>s</i>
THmax	Period of highest wave	<i>s</i>
HCM	Crest height, maximum positive value of all data within one analysis period	<i>cm</i>
Czz10	10 mHz energy density spectrum	<i>cm</i>
H1	Average height over last 1 minute	<i>cm</i>
H5	Average height over last 5 minutes	<i>cm</i>
H10	Average height over last 10 minutes	<i>cm</i>

Table 1: Default parameters

All possible parameters

Tables 2 to 7, describe all the parameters that can be measured and calculated by the WaveGuide Height & Tide system.

Adding parameters that are not available by default is possible. Added parameters will run in the background and will be available for storage and subscription, yet they will not be visible from the user interface. It is strongly recommended that the user requests the changes when the WaveGuide Height & Tide system is ordered such that all necessary tests can be performed at Radac. Post-delivery adjustments to the available parameters are possible upon request, but not recommended.

Name	Description	Unit
heave	Instantaneous water level	cm

Table 2: Raw data at 1.28, 2, 2.56 or 5 [Hz]

Name	Description	Unit
Czz5	5 mHz energy density spectrum	mHz
WTBH	Table of wave heights	cm
WTBT	Table of wave periods	s
Czz10	10 mHz energy density spectrum	mHz

Table 3: Spectra and wave tables

Name	Description	Unit
Hm0	Significant wave height from M0	cm
M0	Band energy from Czz10(f) in the range $f = [30-500]$ mHz	cm ²
M0_M	Band energy from Czz10(f) in the range $f = [30-1000]$ mHz	cm ²
Hm0_M	Significant wave height from M0_M	cm
Tm02	Average period from M0 and M2 in the range $f = [30-500]$ mHz	s
Tm02_M	Average period from M0 and M2 in the range $f = [30-1000]$ mHz	s
TE0	Band energy from Czz10(f) in the range $f = [500-1000]$ mHz	cm ²
TE1	Band energy from Czz10(f) in the range $f = [200-500]$ mHz	cm ²
TE1_M	Band energy from Czz10(f) in the range $f = [200-1000]$ mHz	cm ²
TE2	Band energy from Czz10(f) in the range $f = [100-200]$ mHz	cm ²
HTE3	Wave height from TE3 (Band energy from Czz10(f) where $f = [30-100]$ mHz)	cm
Fp	Frequency f where Czz10(f) has its maximum in the range $f = [30-500]$ mHz	mHz
Fp_M	Frequency f where Czz10(f) has its maximum in the range $f = [30-1000]$ mHz	mHz
AV10_H	Number of degrees of freedom in the energy density spectrum ($4 * Ndlr_H$)	—
HS7	Wave height from band energy from Czz5(f) in the range $f = [30-142.5]$ mHz	cm
Tm0_1	Minus first moment period from M-1 and M0 in the range $f = [30-500]$ mHz	s
Tm0_1_M	Minus first moment period from M-1 and M0 in the range $f = [30-1000]$ mHz	s

Table 4: Parameters of spectral processing (over a 20 [min] data block)

Name	Description	Unit
H1/3	Average height of the highest 1/3 of the waves	<i>cm</i>
TH1/3	Average period of the highest 1/3 of the waves	<i>s</i>
H1/10	Average height of the highest 1/10 of the waves	<i>cm</i>
H1/50	Average height of the highest 1/50 of the waves	<i>cm</i>
T1/3	Average period of the longest 1/3 of the periods	<i>s</i>
GGH	Average height of all waves	<i>cm</i>
GGT	Average period of all waves	<i>s</i>
AG2	Number of waves	—
SPGH	Standard deviation of the wave height	<i>cm</i>
SPGT	Standard deviation of the wave period	<i>s</i>
Hmax	Height of highest wave	<i>cm</i>
Tmax	Period of longest wave	<i>s</i>
THmax	Period of highest wave	<i>s</i>
HCM	Crest height, maximum positive value of all data within one analysis period	<i>cm</i>

Table 5: Parameters from time domain processing of data collected (over a 20 [min] data block)

Name	Description	Unit
Nwt_zP	Sum of periods of waves divided by analysis period	—
Ndlr_H	Number of valid sub-series of the signal in the vertical direction	—
Ngd_zP	Percentage of data-points that do not contain error code before pre-processing	—
Nu_z	Number of valid data-points that are rejected because of 0-sigma errors	—
Nv_z	number of valid data-points that are rejected because of 4-sigma errors	—
Nd_z	number of valid data-points that are rejected because of 4-delta errors	—
Ni_z	number of interpolated or extrapolated vertical wave motion datapoints	—

Table 6: Quality parameters (over a 20 [min] data block)

Name	Description	Unit
H	Average height over last 10 seconds	<i>cm</i>
H1	Average height over last 1 minute	<i>cm</i>
H5	Average height over last 5 minutes	<i>cm</i>
H10	Average height over last 10 minutes	<i>cm</i>

Table 7: parameters from tide processing

Appendix 2: System specifications

WaveGuide radar

Mechanical

Dimensions	26.5 x 26 [cm] (diameter, height)
Weight	≈ 12 [kg]
Casing material	Stainless Steel

Electrical

Radar frequency	9.9 – 10.2 [GHz]
Modulation	Triangular FMCW
Emission	The emitted microwave energy is far below acceptable limits for exposure of the human body. Depending on the type of antenna, a maximum radiation of 0.1 [mW] is generated.
Power requirements	24-64 [VDC] and 6 [Watt] (when powered separately from processing unit).

Environmental conditions

Ambient temperature	-40 to 60 [°C]
Relative humidity	0 – 100 %
Ingress protection	IP67

WaveGuide processing unit

Dimensions	170 x 172 x 85 [mm] (depth x width x height) 19" rack mounting available on request
Processor	ARM Cortex™A9 792MHz
Radar connection	3 x RS485 serial port
Serial data export	2 x RS232 (COM1 and COM2)
Network data export	3 x Ethernet port for configuration, data viewing and data export
Power requirements	24-48 [VDC] and 22.8 [Watt] if radars are powered via processing unit 12-48 [VDC] and 4.8 [Watt] if the processing unit has no radars connected
Operating temperature	-40 to 65 [°C]
Cooling	No fan required
Display	2 x 20 characters
Memory	On board flash

General system specifications

sampling rate	2.56 [Hz]
wave heights	0 – 60 [m]
wave periods	0 – 1 [Hz]
accuracy water level	< 1 [cm]
processing period:	
wave height	20 [min] (SWAP standard)
tide	1, 5 and 10 [min])
processing interval:	
wave height	moving window, all parameters refreshed every 1 minute
tide	moving window, all parameters refreshed every 1 minute